

Module top sheet

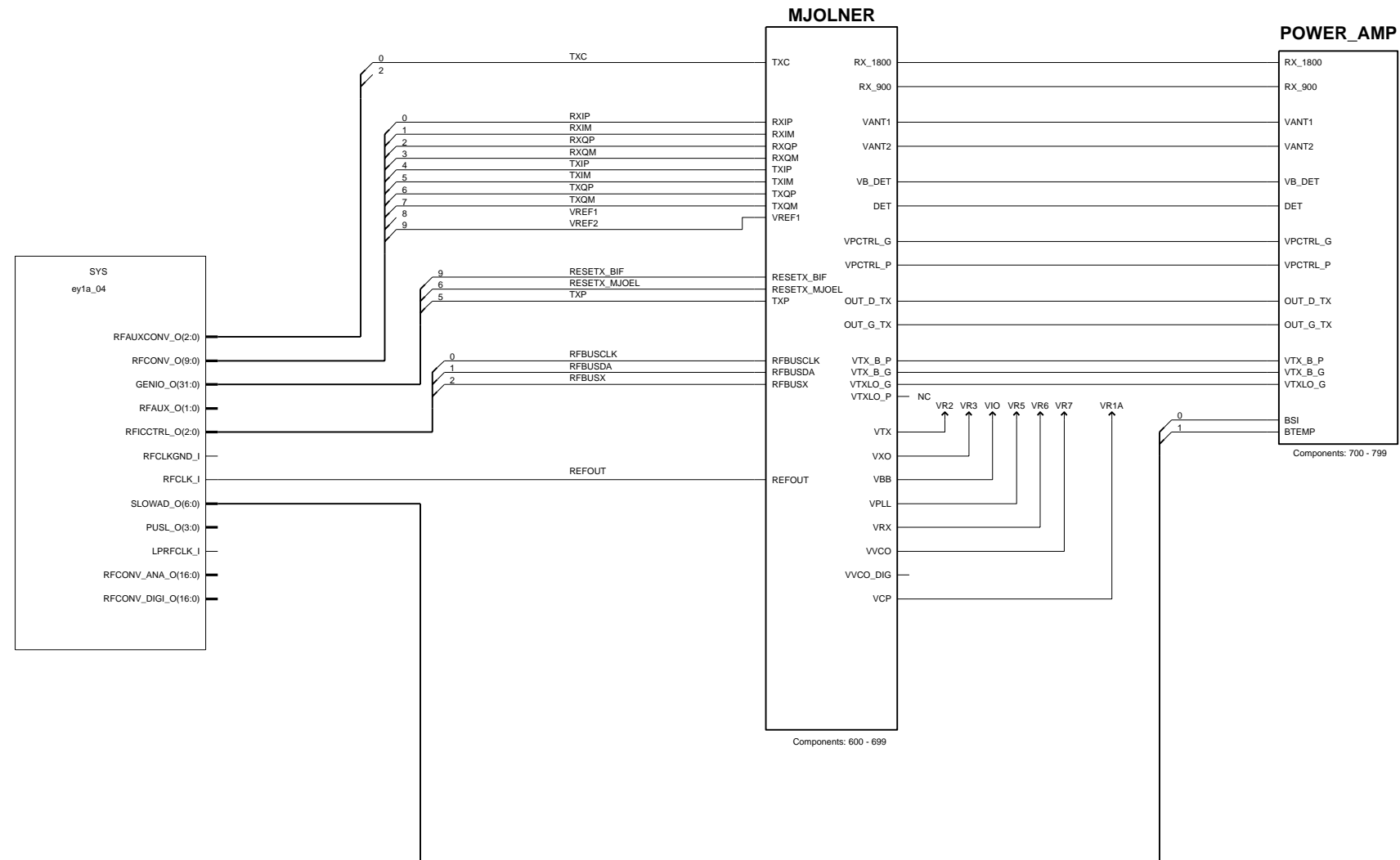

Shielding's cans

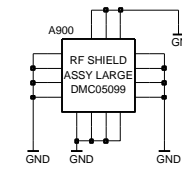
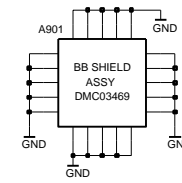
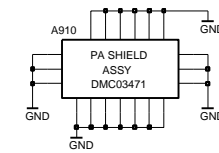
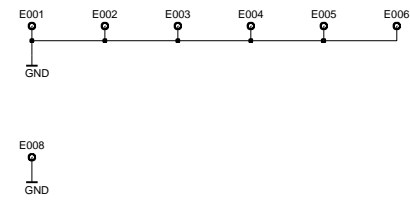

BB top sheet

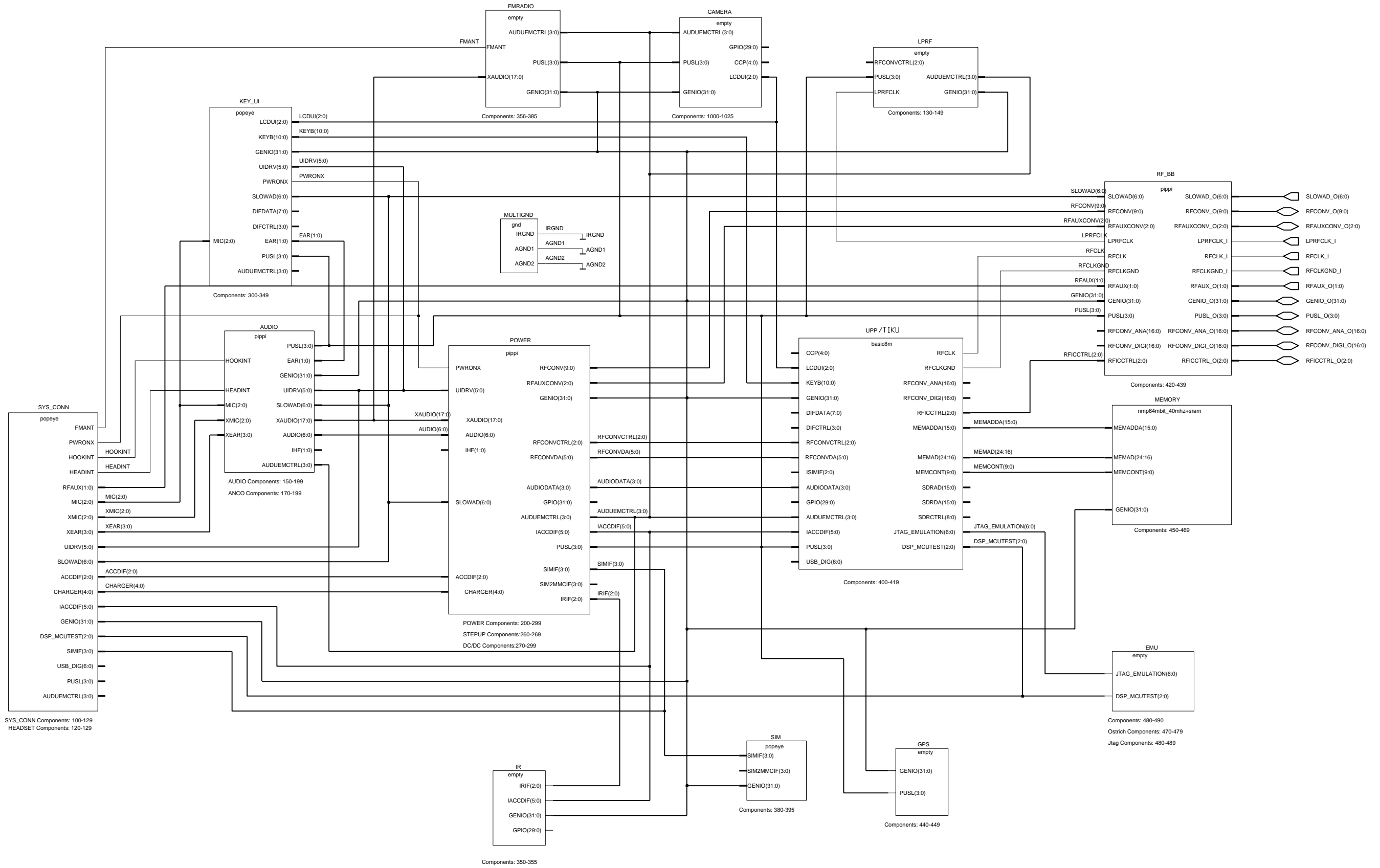

System connector

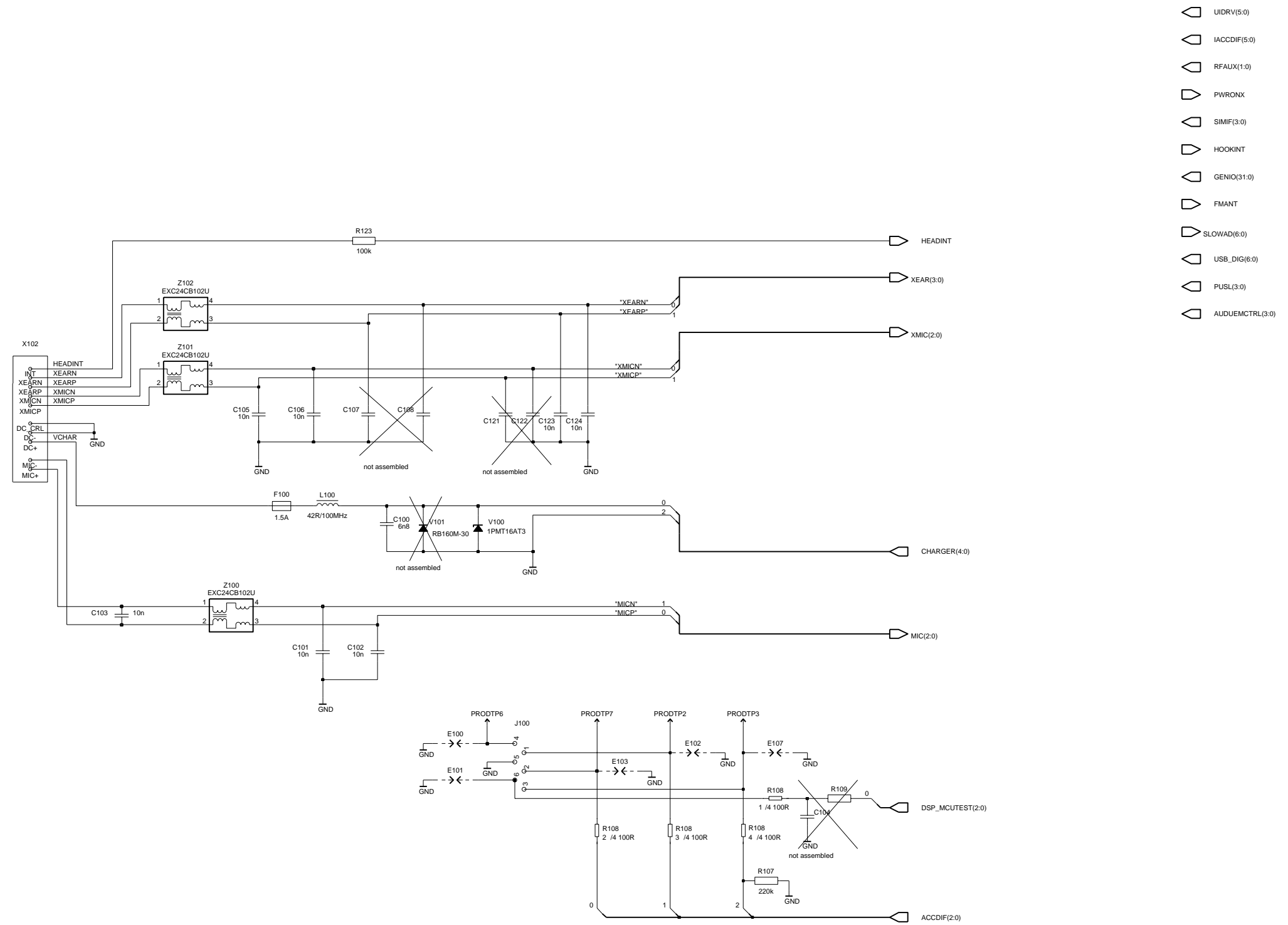

U/I, key and functional cover

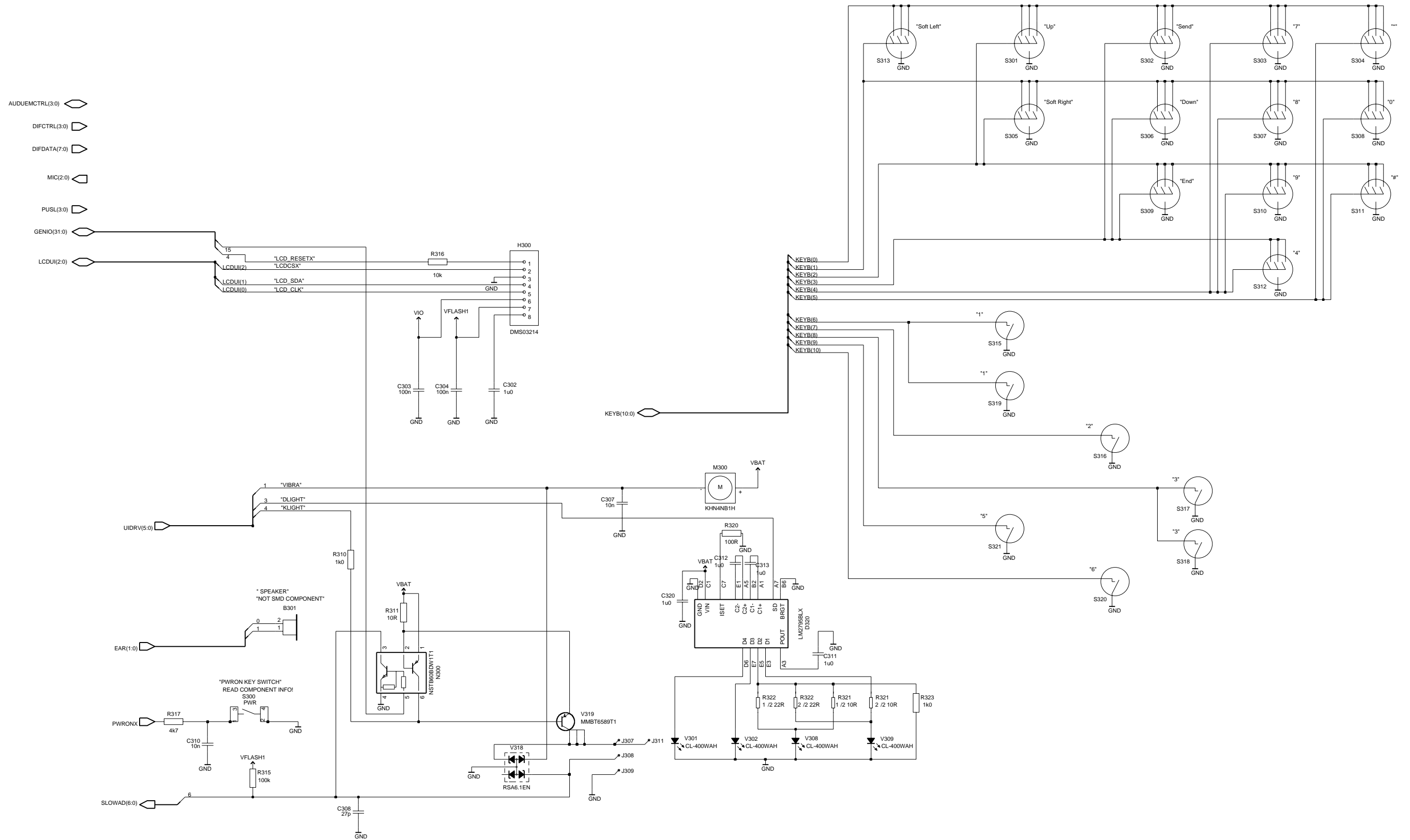

SIM

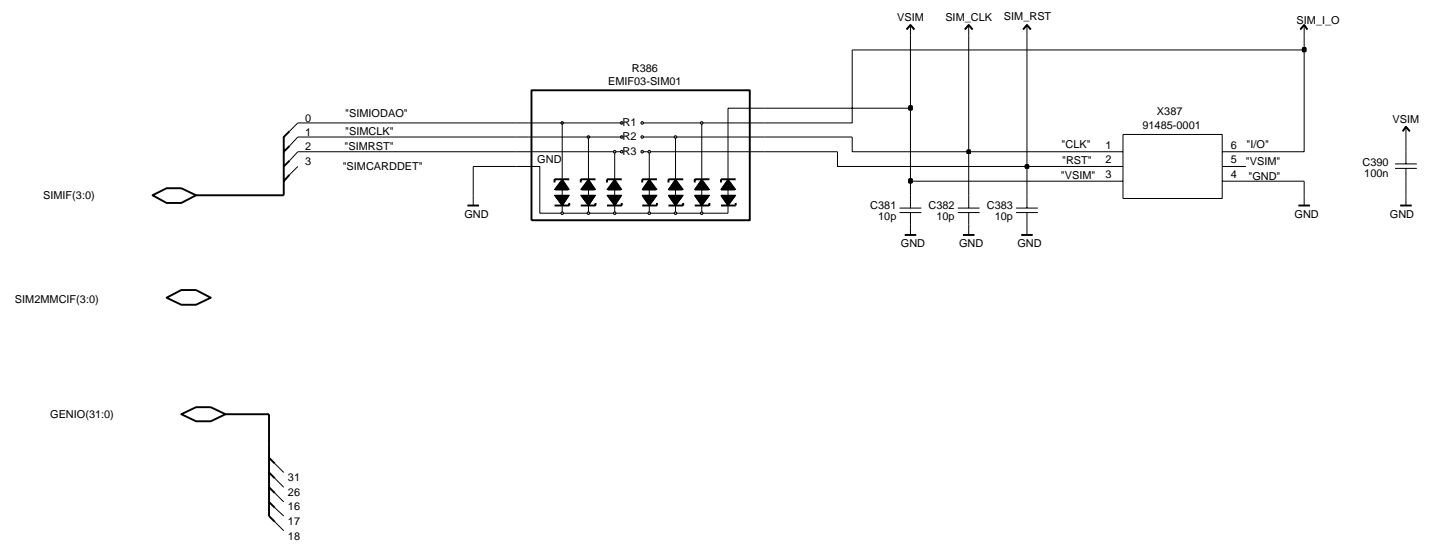

UEM

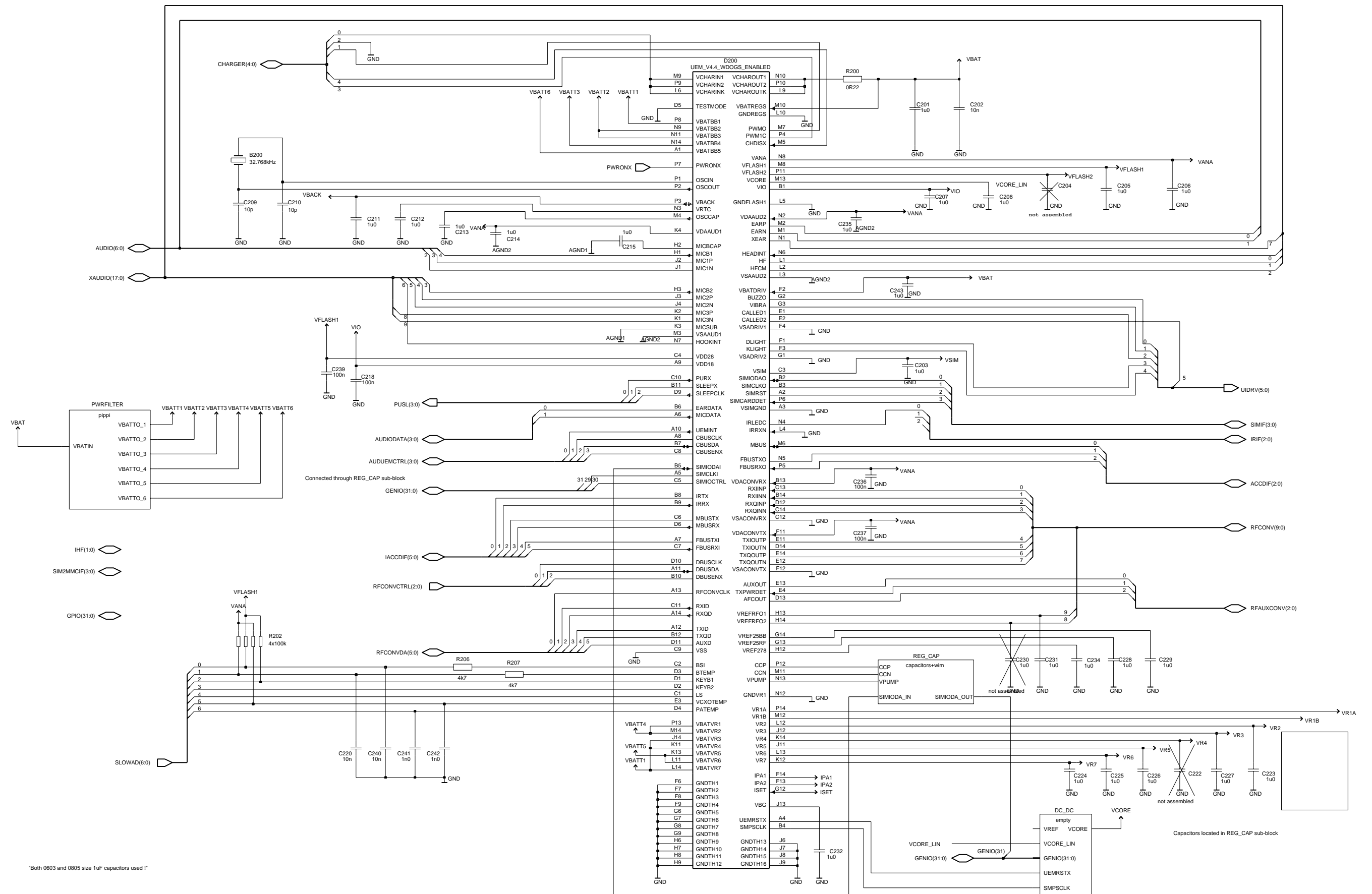

Vcore

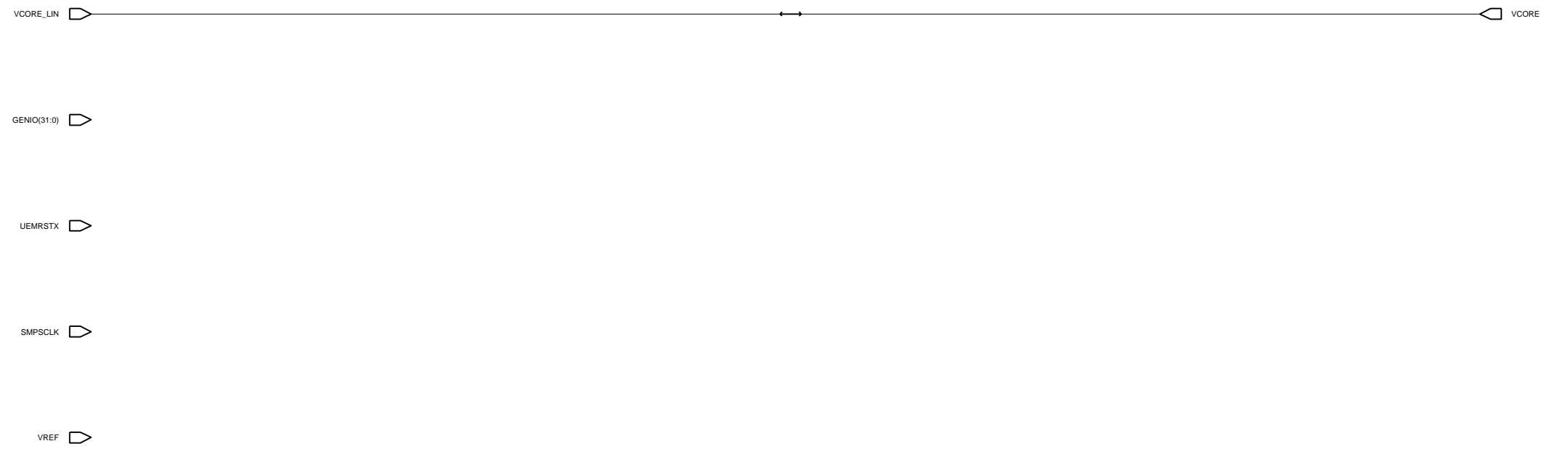

Vbat filter

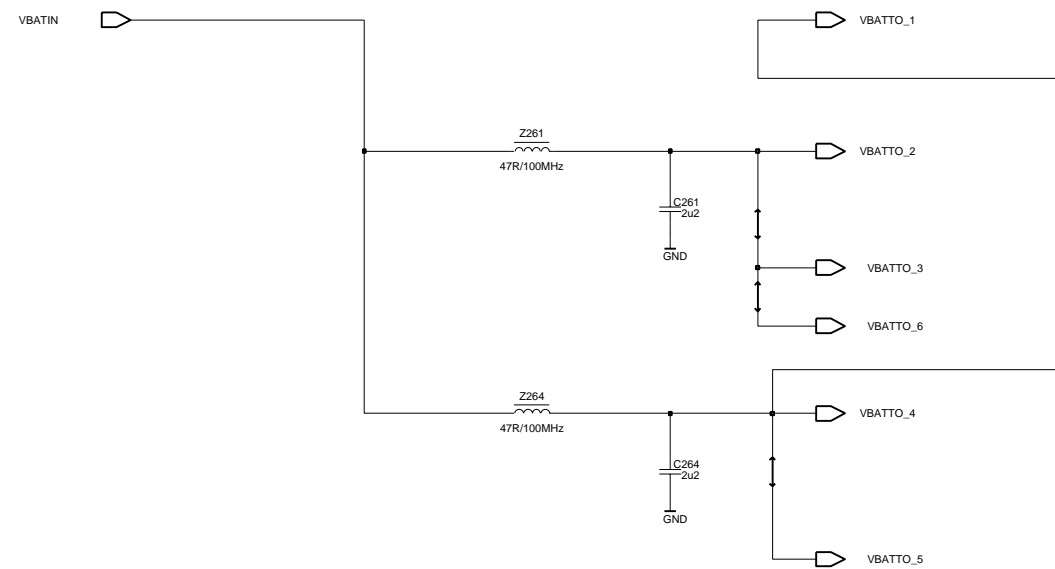

UEM charge pump

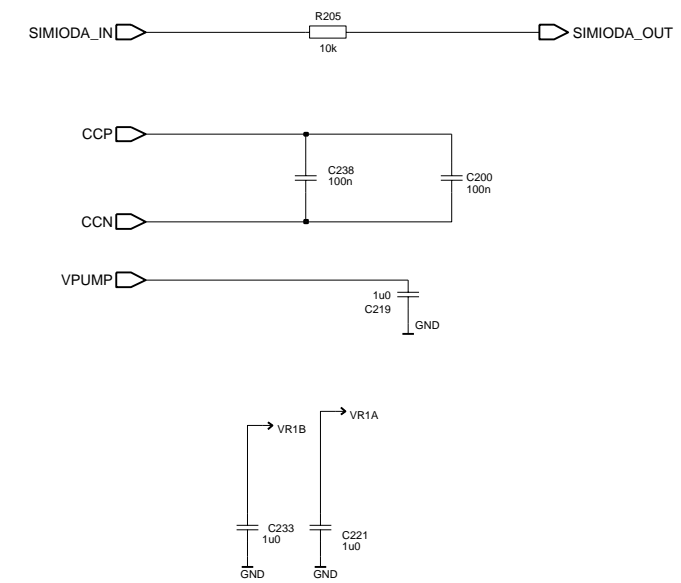

UPP decoupling

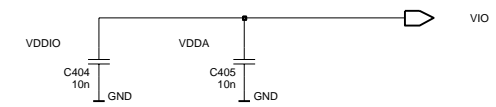
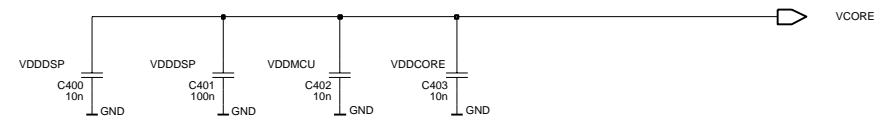

Memory

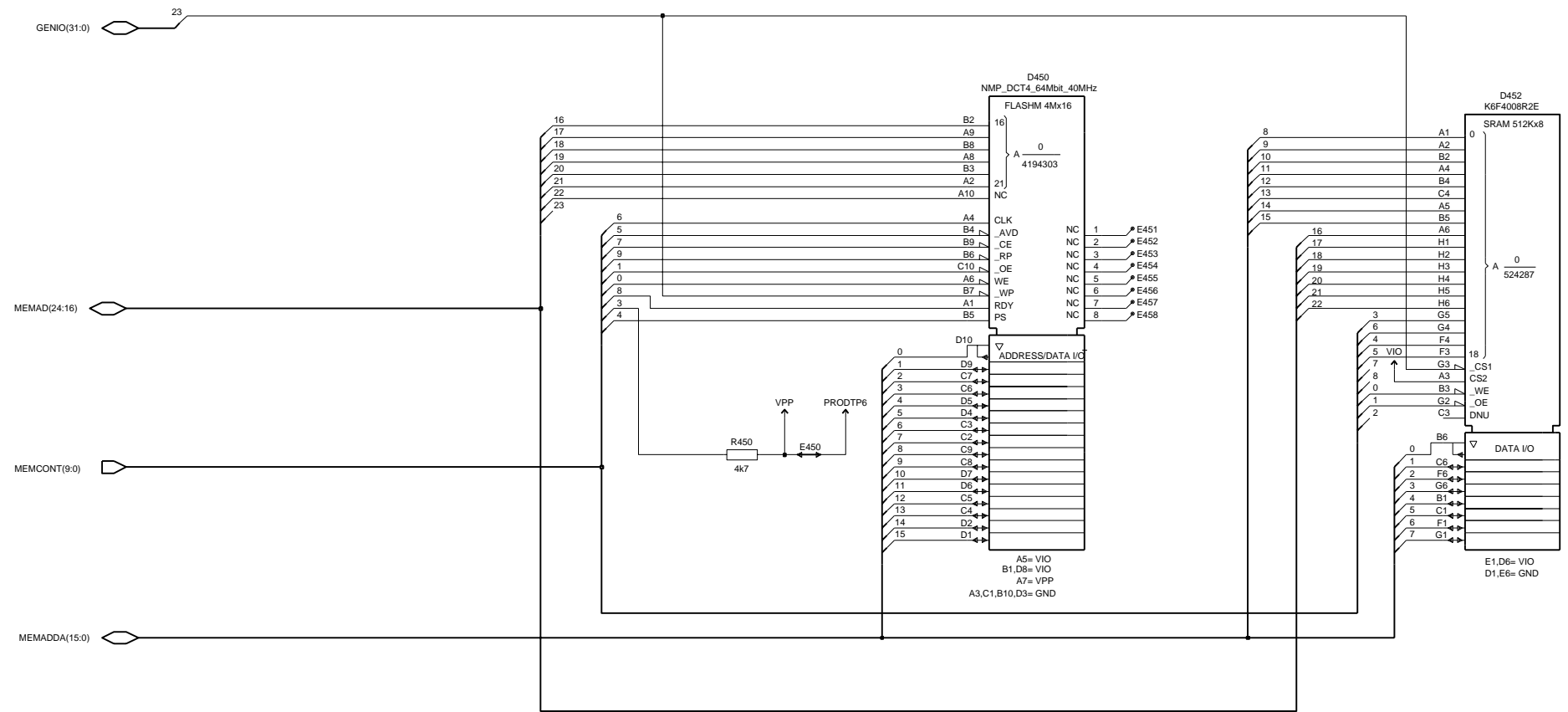
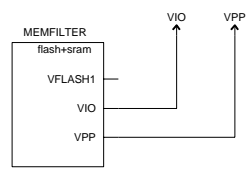

Memory decoupling

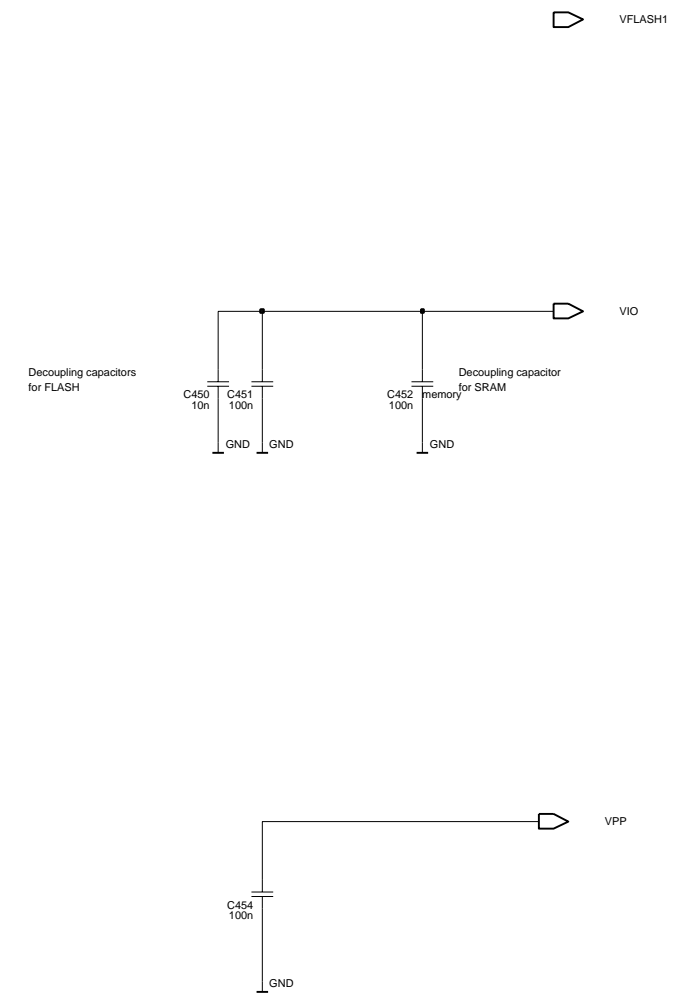

BB-RF

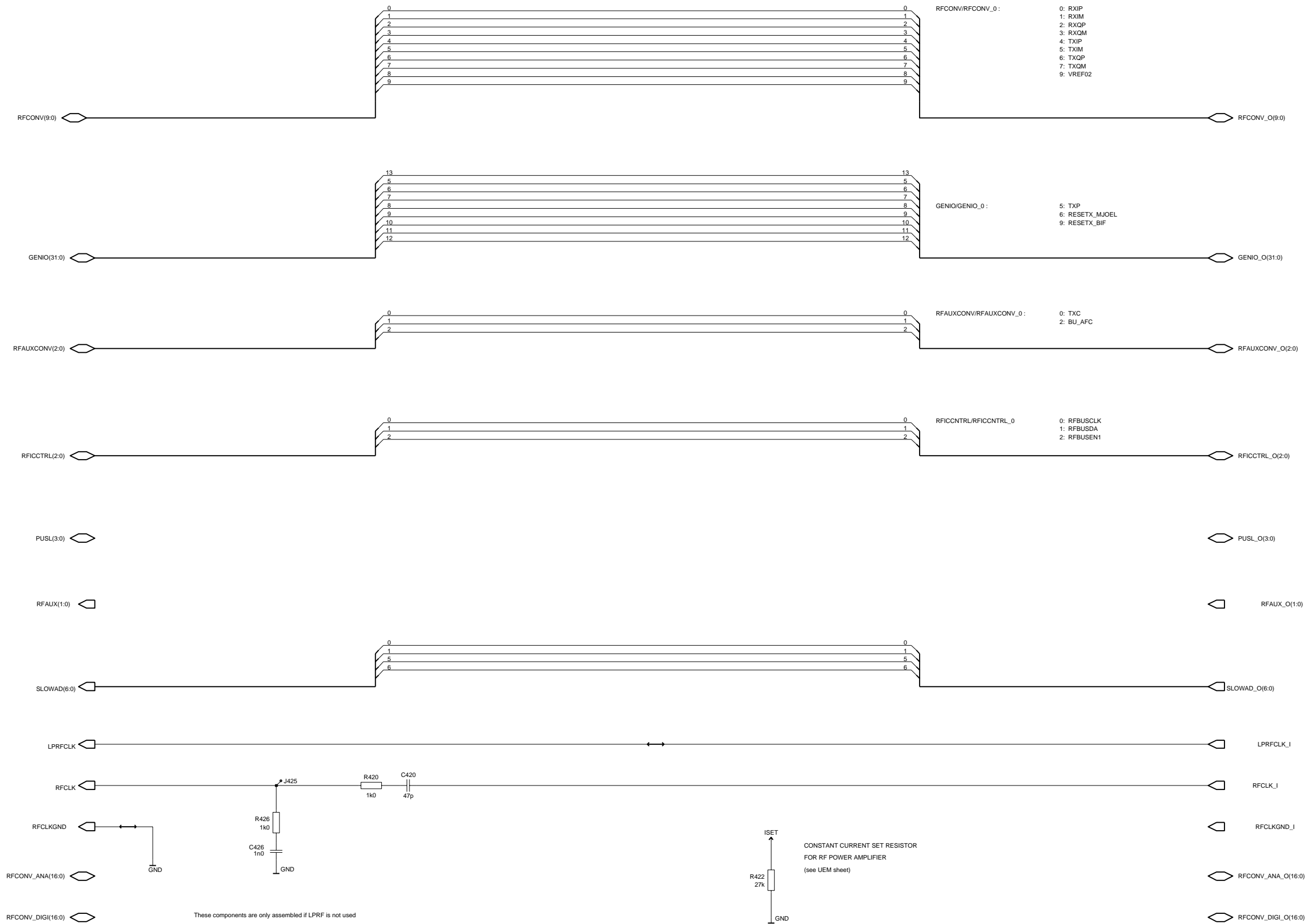

Audio

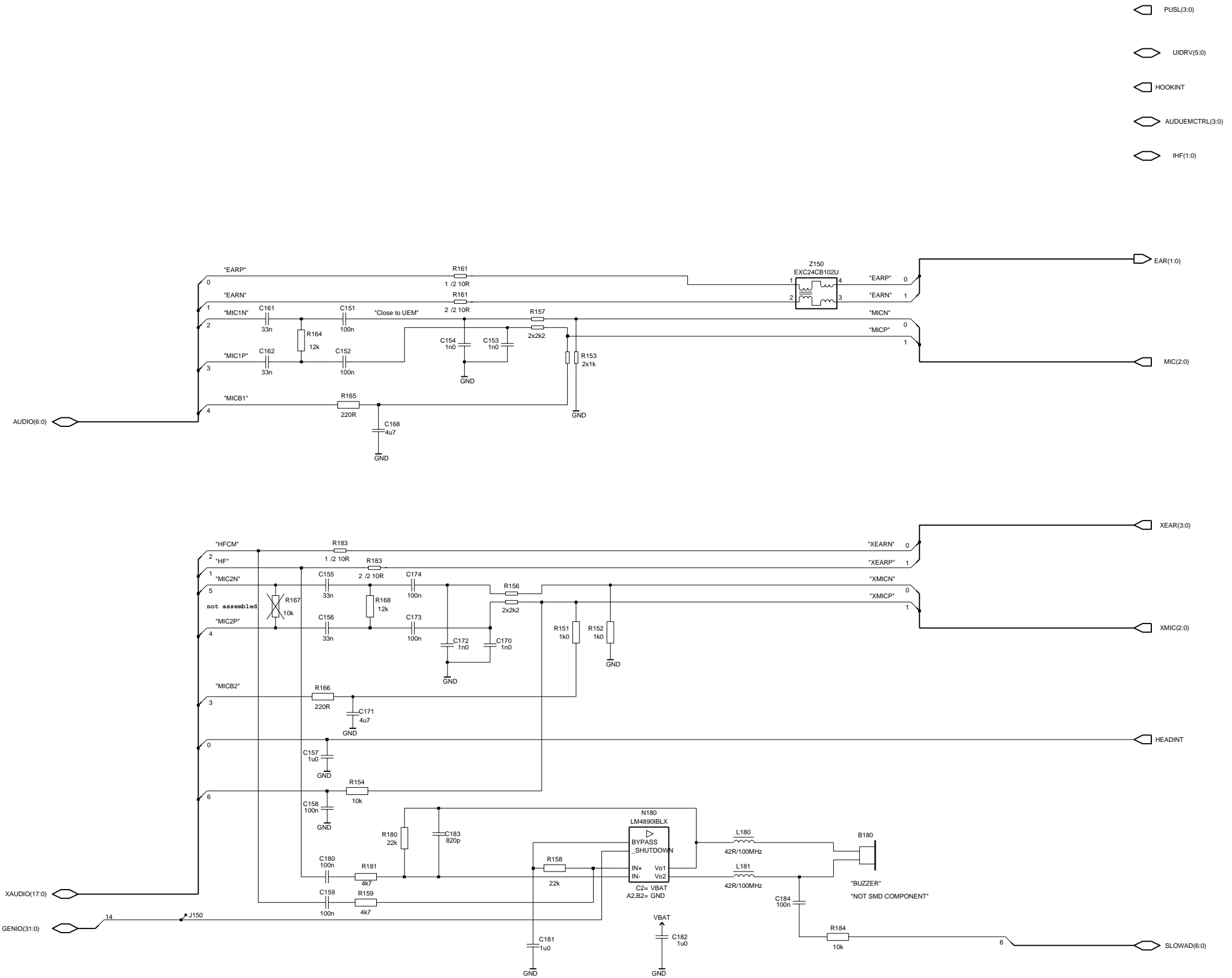

- PUSL(3:0)
- UIDRV(5:0)
- HOOKINT
- AUDUEMCTRL(3:0)
- IHF(1:0)

Multignd

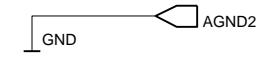
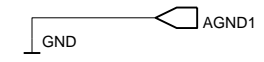
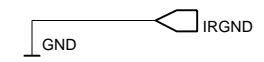

Power amplifier

||

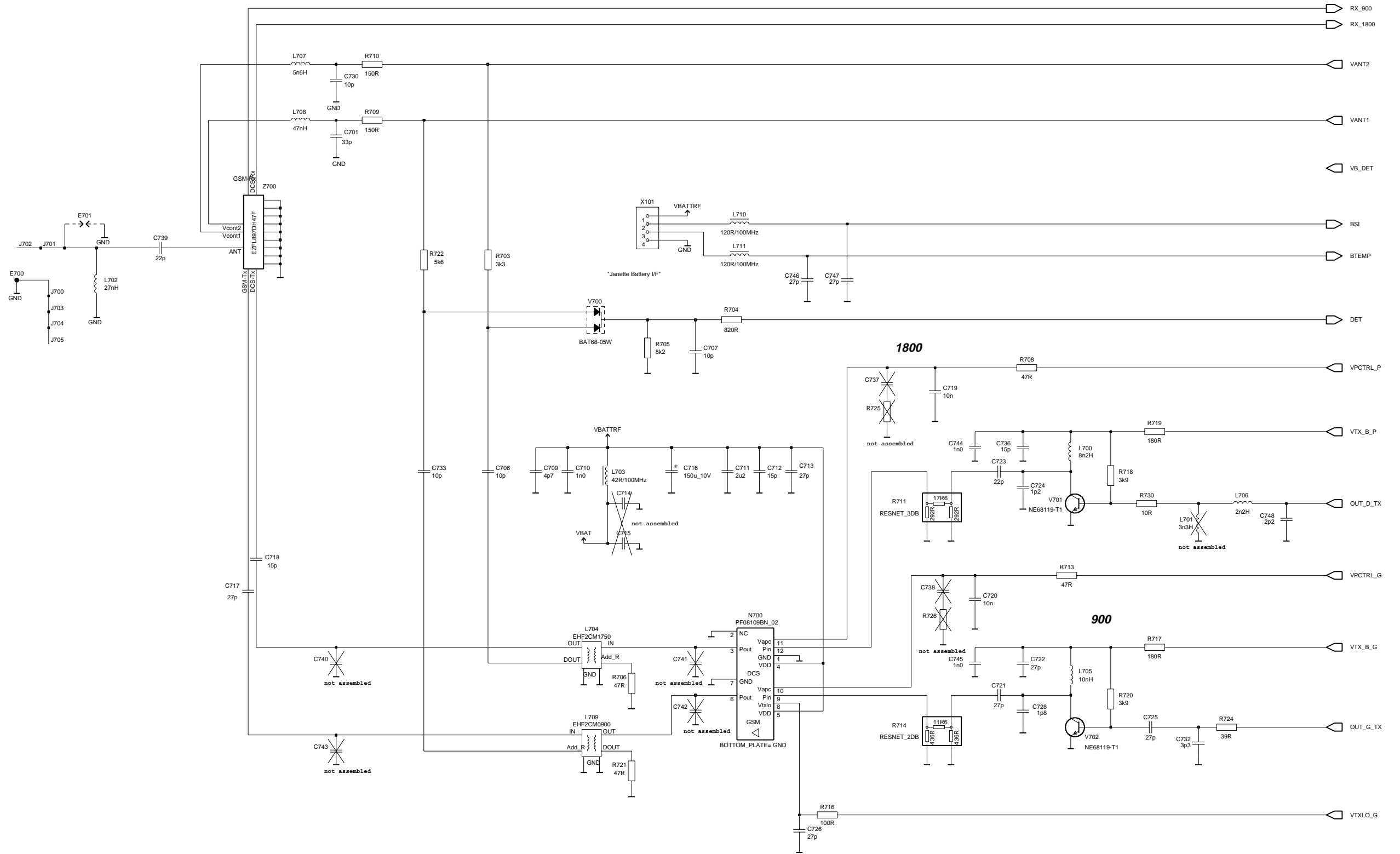

Mjoelner

